



Listing and Technical Evaluation Report

Report No: 2311-02



Issue Date: January 4, 2024

Revision Date: January 4, 2024

Subject to Renewal: January 1, 2025

DRYline® SIX Structural Insulation Board

Trade Secret Report Holder:

National Shelter Products, Inc.

Phone: 425-557-7968

Website: www.nationalshelter.com

Email: support@nationalshelter.com

CSI Designations:

DIVISION: 06 00 00 - WOOD, PLASTICS AND COMPOSITES

DIVISION: 07 00 00 - THERMAL AND MOISTURE PROTECTION

Section: 06 12 00 - Structural Panels

Section: 07 21 00 - Thermal Insulation

Section: 06 12 19 - Shear Wall Panels

Section: 07 25 00 - Water-Resistive Barriers/Weather Barriers

Section: 06 16 00 - Sheathing

Section: 07 27 00 - Air Barriers

1 Innovative Products Evaluated¹

1.1 DRYline® SIX Structural Insulation Board

2 Product Description and Materials

2.1 The innovative products evaluated in this report are shown in **Figure 1**.



Figure 1. DRYline® SIX Structural Insulation Board Product



- 2.2 DRYline® SIX Structural Insulation Board is structural insulating sheathing product composed of Neopor® Rigid Foam Insulation and fiberboard. A film is applied to the foam on the opposing side of the fiberboard.
- 2.3 DRYline® SIX Structural Insulation Board consists of the following materials:
 - 2.3.1 *Foam Plastics Insulation Sheathing:*
 - 2.3.1.1 Expanded polystyrene (EPS): Neopor®, 5/8" (16 mm) thick or 1 1/8" (29 mm) thick
 - 2.3.2 *Fiberboard:*
 - 2.3.2.1 Thickness 0.108" (2.7 mm)
- 2.4 Neopor® may be installed against the studs (foam in) with the fiberboard on the exterior face of the wall, or the fiberboard may be installed against the studs with Neopor® on the exterior face of the wall (foam out).
- 2.5 *Material Availability*
 - 2.5.1 DRYline® SIX Structural Insulation Board R3 Nominal Thickness: 3/4" (19 mm)
 - 2.5.2 DRYline® SIX Structural Insulation Board R5 Nominal Thickness: 1 1/8" (29 mm)
 - 2.5.3 *Standard Width:*
 - 2.5.3.1 4' (1,219 mm)
 - 2.5.4 *Standard Lengths:*
 - 2.5.4.1 8' (2,438 mm)
 - 2.5.4.2 9' (2,743 mm)
 - 2.5.4.3 10' (3,048 mm)
- 2.6 Where the name "DRYline® SIX Structural Insulation Board" is used in this report, both the R3 and R5 products apply.
- 2.7 As needed, review material properties for design in Section 6 and to regulatory evaluation in Section 8.

3 Definitions

- 3.1 New Materialsⁱⁱ are defined as building materials, equipment, appliances, systems or methods of construction not provided for by prescriptive and/or legislatively adopted regulations, known as alternative materials.ⁱⁱⁱ The design strengths and permissible stresses shall be established by tests^{iv} and/or engineering analysis.^v
- 3.2 Duly Authenticated Reports^{vi} and Research Reports^{vii} are test reports and related engineering evaluations, which are written by an approved agency^{viii} and/or an approved source.^{ix}
 - 3.2.1 These reports contain intellectual property and/or trade secrets, which are protected by the Defend Trade Secrets Act (DTSA).^x
- 3.3 An approved agency is "approved" when it is ANAB ISO/IEC 17065 accredited. DrJ Engineering, LLC (DrJ) is listed in the ANAB directory.
- 3.4 An approved source is "approved" when a professional engineer (i.e., Registered Design Professional [RDP]) is properly licensed to transact engineering commerce. The regulatory authority governing approved sources is the state legislature via its professional engineering regulations.^{xi}
- 3.5 Testing and/or inspections conducted for this Duly Authenticated Report were performed by an ISO/IEC 17025 accredited testing laboratory, an ISO/IEC 17020 accredited inspection body and/or a licensed RDP.
 - 3.5.1 The Center for Building Innovation (CBI) is ANAB^{xii} ISO/IEC 17025 and ISO/IEC 17020 accredited.
- 3.6 The regulatory authority shall enforce^{xiii} the specific provisions of each legislatively adopted regulation. If there is a non-conformance, the specific regulatory section and language of the non-conformance shall be provided in writing^{xiv} stating the nonconformance and the path to its cure.
- 3.7 The regulatory authority shall accept Duly Authenticated Reports from an approved agency and/or an approved source with respect to the quality and manner of use of new materials or assemblies as provided for in regulations regarding the use of alternative materials, designs or methods of construction.^{xv}



- 3.8 ANAB is an [International Accreditation Forum \(IAF\) Multilateral Recognition Arrangement \(MLA\)](#) signatory where recognition of certificates, validation and verification statements issued by conformity assessment bodies accredited by all other signatories of the IAF MLA with the appropriate scope, shall be approved.^{xvi} Therefore, all ANAB ISO/IEC 17065 [Duly Authenticated Reports](#) are approval equivalent.^{xvii}
- 3.9 Approval equity is a fundamental commercial and legal principle.^{xviii}

4 Applicable Standards for the Listing; Regulations for the Regulatory Evaluation^{xix}

4.1 Standards

- 4.1.1 *AATCC TM127: Water Resistance: Hydrostatic Pressure Test*
- 4.1.2 *ASTM C578: Standard Specification for Rigid, Cellular Polystyrene Thermal Insulation*
- 4.1.3 *ASTM E84: Standard Test Method for Surface Burning Characteristics of Building Materials*
- 4.1.4 *ASTM E96: Standard Test Methods for Water Vapor Transmission of Materials*
- 4.1.5 *ASTM E330: Standard Test Method for Structural Performance of Exterior Windows, Doors, Skylights and Curtain Walls by Uniform Static Air Pressure Difference*
- 4.1.6 *ASTM E331: Standard Test Method for Water Penetration of Exterior Windows, Skylights, Doors, and Curtain Walls by Uniform Static Air Pressure Difference*
- 4.1.7 *ASTM E564: Standard Practice for Static Load Test for Shear Resistance of Framed Walls for Buildings*
- 4.1.8 *ASTM E2178: Standard Test Method for Air Permeance of Building Materials*

4.2 Regulations

- 4.2.1 *IBC – 15, 18, 21: International Building Code®*
- 4.2.2 *IRC – 15, 18, 21: International Residential Code®*
- 4.2.3 *IECC – 15, 18, 21: International Energy Conservation Code®*

5 Listed^{xx}

- 5.1 A nationally recognized [testing laboratory](#) such as CBI, states that the materials, designs, methods of construction and/or equipment have met nationally recognized standards and/or have been tested and found suitable for use in a specified manner.

6 Tabulated Properties Generated from Nationally Recognized Standards

- 6.1 Except as otherwise described in this report, DRYline® SIX Structural Insulation Board shall be installed in accordance with the applicable building codes listed in Section 4 using the provisions set forth herein for the design and installation of wood structural panels (WSP).
- 6.2 DRYline® SIX Structural Insulation Board is used as a wall sheathing in buildings constructed in accordance with the IBC and IRC for light-frame wood construction.
- 6.3 DRYline® SIX Structural Insulation Board is used as a wall sheathing in Type V construction in accordance with the IBC.
- 6.4 DRYline® SIX Structural Insulation Board shall be permitted to be designed in accordance with SDPWS for the design of shear walls using the methods set forth therein, excluding the perforated shear wall methodology, and subject to the SDPWS boundary conditions except as specifically allowed in this report.
- 6.5 Anchorage for in-plane shear shall be provided to transfer the induced shear force into and out of each shear wall.
 - 6.5.1 For wind design, anchor bolt spacing shall not exceed 6' o.c. (1,829 mm).
- 6.6 The maximum aspect ratio for DRYline® SIX Structural Insulation Board shall be 4:1.
- 6.7 The minimum full height panel width shall be 24" (610 mm) in accordance with [IRC Section R602.10.5](#).



- 6.8 All panel edges shall be blocked with a minimum 2" (51 mm) nominal lumber.
- 6.9 Fasteners shall be installed flush with the surface of the fiberboard for both foam in and foam out installation orientations.
- 6.10 Installation is permitted for single top plate (advanced framing method) or double top plate applications.
- 6.11 *Structural Applications*
 - 6.11.1 *Simplified IRC Bracing Provisions:*
 - 6.11.1.1 DRYline® SIX Structural Insulation Board is permitted to be used in accordance with the IRC simplified bracing method of [IRC Section R602.12](#) as modified by **Table 1** for foam in orientations and **Table 2** for foam out orientations. All other provisions of the IRC simplified bracing method shall be met.



Table 1. DRYline® SIX Structural Insulation Board Simplified Bracing Table – Foam In Orientation^{1,2,3,4,5,6,7,8}

Structural Sheathing Product	Ultimate Design Wind Speed, V_{ult} (mph)	Story Level ²	Eave to Ridge Height (ft)	Minimum Number of Bracing Units Required (Long Side)						Minimum Number of Bracing Units Required (Short Side)					
				Length of Short Side (ft)						Length of Long Side (ft)					
				10	20	30	40	50	60	10	20	30	40	50	60
DRYline® SIX Structural Insulation Board (Foam In)	115	One Story or Top of Two or Three Stories	10	1	1	2	2	3	3	1	1	2	2	3	3
		First of Two Story or Second of Three Stories		1	2	3	4	4	5	1	2	3	4	4	5
		First of Three Stories		2	3	4	6	7	8	2	3	4	6	7	8
		One Story or Top of Two or Three Stories	15	1	1	3	3	4	4	1	1	3	3	4	4
		First of Two Story or Second of Three Stories		1	2	3	5	5	6	1	2	3	5	5	6
		First of Three Stories		2	3	4	7	8	9	2	3	4	7	8	9
	130	One Story or Top of Two or Three Stories	10	1	2	2	3	3	4	1	2	2	3	3	4
		First of Two Story or Second of Three Stories		2	3	4	5	6	6	2	3	4	5	6	6
		First of Three Stories		2	4	6	7	9	11	2	4	6	7	9	11
		One Story or Top of Two or Three Stories	15	1	3	3	4	4	5	1	3	3	4	4	5
		First of Two Story or Second of Three Stories		2	3	5	6	7	7	2	3	5	6	7	7
		First of Three Stories		2	4	7	8	10	12	2	4	7	8	10	12

SI: 1 in = 25.4 mm

- This simplified bracing table is based on the provisions of [IRC Section R602.12](#). All provisions therein shall be observed, except that this table shall replace [IRC Table R602.12.4](#), and DRYline® SIX Structural Insulation Board shall replace the sheathing material.
- DRYline® SIX Structural Insulation Board installed with butted joints on 2x4 studs spaced 16" o.c. and fastened with a minimum 1³/₄" x 0.120" nails installed 3" o.c. along the edges and 3" o.c. in the field. Fastener edge distance shall be a minimum of 3/8". Nails with a head diameter and length greater than the 1³/₄" x 0.120" nails are also permissible.
- Minimum 1/2" gypsum wallboard attached to the interior side of the wall in accordance with [IRC Section R702.3.5](#) and [IRC Table R702.3.5](#).
- Interpolation shall not be permitted.
- Cripple walls or wood-framed basement walls in a walk-out condition shall be designated as the first story and the stories above shall be re-designated as the second and third stories, respectively, and shall be prohibited in a three-story structure.
- Actual lengths of the sides of the circumscribed rectangle shall be rounded to the next highest unit of 10 when using this table.
- For Exposure Category C, multiply bracing units by a factor of 1.20 for a one-story building, 1.30 for a two-story building, and 1.40 for a three-story building.
- Maximum stud spacing is 16" o.c.



Table 2. DRYline® SIX Structural Insulation Board Simplified Bracing Table – Foam Out Orientation^{1,2,3,4,5,6,7,8}

Structural Sheathing Product	Ultimate Design Wind Speed, V_{ult} (mph)	Story Level ²	Eave to Ridge Height (ft)	Minimum Number of Bracing Units Required (Long Side)						Minimum Number of Bracing Units Required (Short Side)					
				Length of Short Side (ft)						Length of Long Side (ft)					
				10	20	30	40	50	60	10	20	30	40	50	60
DRYline® SIX Structural Insulation Board (Foam Out)	115	One Story or Top of Two or Three Stories	10	1	1	2	2	3	3	1	1	2	2	3	3
		First of Two Story or Second of Three Stories		1	2	3	4	4	5	1	2	3	4	4	5
		First of Three Stories		2	3	4	6	7	8	2	3	4	6	7	8
		One Story or Top of Two or Three Stories	15	1	1	3	3	4	4	1	1	3	3	4	4
		First of Two Story or Second of Three Stories		1	2	3	5	5	6	1	2	3	5	5	6
		First of Three Stories		2	3	4	7	8	9	2	3	4	7	8	9
	130	One Story or Top of Two or Three Stories	10	1	2	2	3	3	4	1	2	2	3	3	4
		First of Two Story or Second of Three Stories		2	3	4	5	6	6	2	3	4	5	6	6
		First of Three Stories		2	4	6	7	9	11	2	4	6	7	9	11
		One Story or Top of Two or Three Stories	15	1	3	3	4	4	5	1	3	3	4	4	5
		First of Two Story or Second of Three Stories		2	3	5	6	7	7	2	3	5	6	7	7
		First of Three Stories		2	4	7	8	10	12	2	4	7	8	10	12

SI: 1 in = 25.4 mm

- This simplified bracing table is based on the provisions of [IRC Section R602.12](#). All provisions therein shall be observed, except that this table shall replace [IRC Table R602.12.4](#), and DRYline® SIX Structural Insulation Board shall replace the sheathing material.
- DRYline® SIX Structural Insulation Board installed with butted joints on 2x4 studs spaced 16" o.c. and fastened as follows with spacing 3" o.c. along the edges and 3" o.c. in the field. Fastener edge distance shall be a minimum of $\frac{3}{8}$ ".
 - DRYline® SIX Structural Insulation Board R3: "N"-style 16-gauge galvanized staple ($\frac{1}{2}$ " crown x $1\frac{1}{4}$ " leg), or 1" crown x $1\frac{1}{4}$ " leg
 - DRYline® SIX Structural Insulation Board R5: 16-gauge galvanized staple (1" crown x 2" leg)
- Minimum $\frac{1}{2}$ " gypsum wallboard attached to the interior side of the wall in accordance with [IRC Section R702.3.5](#) and [IRC Table R702.3.5](#).
- Interpolation shall not be permitted.
- Cripple walls or wood-framed basement walls in a walk-out condition shall be designated as the first story and the stories above shall be re-designated as the second and third stories, respectively, and shall be prohibited in a three-story structure.
- Actual lengths of the sides of the circumscribed rectangle shall be rounded to the next highest unit of 10 when using this table.
- For Exposure Category C, multiply bracing units by a factor of 1.20 for a one-story building, 1.30 for a two-story building, and 1.40 for a three-story building.
- Maximum stud spacing is 16" o.c.



6.11.2 Prescriptive IRC Bracing Applications:

6.11.2.1 DRYline® SIX Structural Insulation Board may be used in the following applications:

- 6.11.2.1.1 On braced wall lines equivalent to the IRC Method WSP (Wood Structural Panel) when installed in accordance with IRC Section R602.10.4 and this report.
- 6.11.2.1.2 To brace walls of buildings equivalent to the IRC Method CS-WSP (Continuously Sheathed Wood Structural Panel) when installed in accordance with IRC Section R602.10.4 and this report.
- 6.11.2.1.3 To brace walls of buildings equivalent to the IRC Method CS-PF (Continuously Sheathed Portal Frame), in lieu of WSP, when installed in accordance with IRC Section R602.10.6.4.
- 6.11.2.1.4 To brace walls of buildings equivalent to the IRC Method PHF (Portal Frame with Hold-downs) when installed in accordance with IRC Section R602.10.6.2.
- 6.11.2.2 All other IRC prescriptive bracing minimums, spacing requirements, and rules must also be met.
- 6.11.2.3 Where a building, or portion thereof, does not comply with one or more of the bracing requirements within the prescriptive section of the IRC, those portions shall be designed and constructed in accordance with IRC Section R301.1.
- 6.11.2.4 *Wind Bracing:*
 - 6.11.2.4.1 Required braced wall panel lengths are provided in **Table 3** and **Table 4** for foam in orientations and **Table 5** for foam out orientations. These tables shall be used in place of IRC Table R602.10.3(1). All adjustment factors from IRC Table R602.10.3(2) shall still be applied.



Table 3. IRC Bracing Requirements for DRYline® SIX Structural Insulation Board R3 (Foam In) – Wind^{1,2,3,4,5}

Condition	Braced Wall Line Spacing (ft)	Minimum Total Length (ft) of Braced Wall Panels Required Along Each Braced Wall Line									
		Intermediate Sheathing					Continuous Sheathing				
		Ultimate Design Wind Speed, ⁶ V _{ult} (mph)									
		≤ 110	≤ 115	≤ 120	≤ 130	< 140	≤ 110	≤ 115	≤ 120	≤ 130	< 140
One Story or the Top of Two or Three Stories	10	1.7	1.7	2.2	2.2	2.6	1.3	1.7	1.7	2.2	2.2
	20	3.0	3.0	3.4	4.3	4.7	2.6	3.0	3.0	3.4	4.3
	30	4.3	4.7	5.2	6.0	6.9	3.9	3.9	4.3	5.2	6.0
	40	5.6	6.0	6.9	7.8	9.0	4.7	5.2	5.6	6.5	7.8
	50	6.9	7.8	8.2	9.5	11.2	6.0	6.5	6.9	8.2	9.5
	60	8.2	9.0	9.9	11.2	12.9	6.9	7.8	8.2	9.5	11.2
First Story of Two Stories or Second Story of Three Stories	10	3.0	3.4	3.9	4.3	5.2	2.6	3.0	3.0	3.9	4.3
	20	5.6	6.5	6.9	8.2	9.5	4.7	5.6	6.0	6.9	7.8
	30	8.2	9.0	9.9	11.6	13.4	6.9	7.8	8.2	9.9	11.2
	40	10.8	11.6	12.9	15.1	17.2	9.0	9.9	10.8	13.4	14.6
	50	13.4	14.2	15.5	18.5	21.1	11.2	12.1	13.4	15.5	18.1
	60	15.5	17.2	18.5	21.5	25.0	13.4	14.6	15.9	18.5	21.5
First Story of Three Stories	10	4.7	5.2	5.6	6.5	7.3	3.9	4.3	4.7	5.6	6.5
	20	8.6	9.5	9.9	11.6	13.8	7.3	7.8	8.6	9.9	11.6
	30	12.1	13.4	14.6	16.8	19.8	10.3	11.2	12.5	14.6	16.8
	40	15.9	17.2	19.0	22.0	25.4	13.4	14.6	15.9	19.0	21.5
	50	19.4	21.1	23.3	27.1	31.4	16.4	18.1	19.8	22.8	26.7
	60	22.8	25.0	27.6	32.3	37.0	19.8	21.5	23.3	27.1	31.4

SI: 1 in = 25.4 mm, 1 mph = 1.61 km/h

1. Demonstrates equivalency to IRC Table R602.10.3(1). All adjustment factors from IRC Table R602.10.3(2) shall be applied.
2. DRYline® SIX Structural Insulation Board installed with butted joints on 2x4 studs spaced 16" o.c. and fastened with a minimum 1 3/4" x 0.120" nails installed 3" o.c. along the edges and 3" o.c. in the field. Fastener edge distance shall be a minimum of 3/8". Nails with a head diameter and length greater than the 1 3/4" x 0.120" nails are also permissible.
3. Minimum 1/2" gypsum wallboard shall be installed as part of the wall assembly. Where gypsum wallboard is not applied to the interior side of the wall assembly, bracing lengths shall be multiplied by a factor of 1.4.
4. Linear interpolation is permitted.
5. Bracing lengths are the result of comparative equivalency testing and analysis using both tested and published design values as points of comparison. DrJ relies upon the design values published in the codes and standards listed in Section 4 that are adopted into law and that the manufacturers of those products stand behind. DrJ performs all equivalency analysis based on legally defined design values, the responsibility for which is the manufacturer of those products or the members of the associations that publish those design values.
6. Wind speeds are V_{ult} in accordance with ASCE 7-22. Use $V_{asd} = V_{ult} \sqrt{0.6}$ to convert to equivalent V_{asd} wind speed in accordance with IBC Section 1609.3.1.



Table 4. IRC Bracing Requirements for DRYline® SIX Structural Insulation Board R5 (Foam In) – Wind^{1,2,3,4,5}

Condition	Braced Wall Line Spacing (ft)	Minimum Total Length (ft) of Braced Wall Panels Required Along Each Braced Wall Line									
		Intermediate Sheathing					Continuous Sheathing				
		Ultimate Design Wind Speed, ⁶ V _{ult} (mph)									
		≤ 110	≤ 115	≤ 120	≤ 130	< 140	≤ 110	≤ 115	≤ 120	≤ 130	< 140
One Story or the Top of Two or Three Stories	10	1.9	1.9	2.3	2.3	2.8	1.4	1.9	1.9	2.3	2.3
	20	3.3	3.3	3.7	4.7	5.1	2.8	3.3	3.3	3.7	4.7
	30	4.7	5.1	5.6	6.5	7.5	4.2	4.2	4.7	5.6	6.5
	40	6.1	6.5	7.5	8.4	9.8	5.1	5.6	6.1	7.0	8.4
	50	7.5	8.4	8.9	10.3	12.2	6.5	7.0	7.5	8.9	10.3
	60	8.9	9.8	10.8	12.2	14.0	7.5	8.4	8.9	10.3	12.2
First Story of Two Stories or Second Story of Three Stories	10	3.3	3.7	4.2	4.7	5.6	2.8	3.3	3.3	4.2	4.7
	20	6.1	7.0	7.5	8.9	10.3	5.1	6.1	6.5	7.5	8.4
	30	8.9	9.8	10.8	12.6	14.5	7.5	8.4	8.9	10.8	12.2
	40	11.7	12.6	14.0	16.4	18.7	9.8	10.8	11.7	14.5	15.9
	50	14.5	15.4	16.8	20.1	22.9	12.2	13.1	14.5	16.8	19.6
	60	16.8	18.7	20.1	23.4	27.1	14.5	15.9	17.3	20.1	23.4
First Story of Three Stories	10	5.1	5.6	6.1	7.0	8.0	4.2	4.7	5.1	6.1	7.0
	20	9.4	10.3	10.8	12.6	15.0	8.0	8.4	9.4	10.8	12.6
	30	13.1	14.5	15.9	18.2	21.5	11.2	12.2	13.6	15.9	18.2
	40	17.3	18.7	20.6	23.9	27.6	14.5	15.9	17.3	20.6	23.4
	50	21.1	22.9	25.3	29.5	34.1	17.8	19.6	21.5	24.8	29.0
	60	24.8	27.1	29.9	35.1	40.2	21.5	23.4	25.3	29.5	34.1

SI: 1 in = 25.4 mm, 1 mph = 1.61 km/h

1. Demonstrates equivalency to IRC Table R602.10.3(1). All adjustment factors from IRC Table R602.10.3(2) shall be applied.
2. DRYline® SIX Structural Insulation Board installed with butted joints on 2x4 studs spaced 16" o.c. and fastened with a minimum 1 3/4" x 0.120" nails installed 3" o.c. along the edges and 3" o.c. in the field. Fastener edge distance shall be a minimum of 3/8". Nails with a head diameter and length greater than the 1 3/4" x 0.120" nails are also permissible.
3. Minimum 1/2" gypsum wallboard shall be installed as part of the wall assembly. Where gypsum wallboard is not applied to the interior side of the wall assembly, bracing lengths shall be multiplied by a factor of 1.4.
4. Linear interpolation is permitted.
5. Bracing lengths are the result of comparative equivalency testing and analysis using both tested and published design values as points of comparison. DrJ relies upon the design values published in the codes and standards listed in Section 4 that are adopted into law and that the manufacturers of those products stand behind. DrJ performs all equivalency analysis based on legally defined design values, the responsibility for which is the manufacturer of those products or the members of the associations that publish those design values.
6. Wind speeds are V_{ult} in accordance with ASCE 7-22. Use $V_{asd} = V_{ult} \sqrt{0.6}$ to convert to equivalent V_{asd} wind speed in accordance with IBC Section 1609.3.1.



Table 5. IRC Bracing Requirements for DRYline® SIX Structural Insulation Board R3 & R5 (Foam Out) – Wind^{1,2,3,4,5}

Condition	Braced Wall Line Spacing (ft)	Minimum Total Length (ft) of Braced Wall Panels Required Along Each Braced Wall Line									
		Intermediate Sheathing					Continuous Sheathing				
		Ultimate Design Wind Speed, ⁶ V _{ult} (mph)									
		≤ 110	≤ 115	≤ 120	≤ 130	< 140	≤ 110	≤ 115	≤ 120	≤ 130	< 140
One Story or the Top of Two or Three Stories	10	1.6	1.6	2.0	2.0	2.3	1.2	1.6	1.6	2.0	2.0
	20	2.7	2.7	3.1	3.9	4.3	2.3	2.7	2.7	3.1	3.9
	30	3.9	4.3	4.7	5.5	6.3	3.5	3.5	3.9	4.7	5.5
	40	5.1	5.5	6.3	7.0	8.2	4.3	4.7	5.1	5.9	7.0
	50	6.3	7.0	7.4	8.6	10.2	5.5	5.9	6.3	7.4	8.6
	60	7.4	8.2	9.0	10.2	11.7	6.3	7.0	7.4	8.6	10.2
First Story of Two Stories or Second Story of Three Stories	10	2.7	3.1	3.5	3.9	4.7	2.3	2.7	2.7	3.5	3.9
	20	5.1	5.9	6.3	7.4	8.6	4.3	5.1	5.5	6.3	7.0
	30	7.4	8.2	9.0	10.6	12.1	6.3	7.0	7.4	9.0	10.2
	40	9.8	10.6	11.7	13.7	15.6	8.2	9.0	9.8	12.1	13.3
	50	12.1	12.9	14.1	16.8	19.2	10.2	10.9	12.1	14.1	16.4
	60	14.1	15.6	16.8	19.5	22.7	12.1	13.3	14.5	16.8	19.5
First Story of Three Stories	10	4.3	4.7	5.1	5.9	6.6	3.5	3.9	4.3	5.1	5.9
	20	7.8	8.6	9.0	10.6	12.5	6.6	7.0	7.8	9.0	10.6
	30	10.9	12.1	13.3	15.2	18.0	9.4	10.2	11.3	13.3	15.2
	40	14.5	15.6	17.2	19.9	23.1	12.1	13.3	14.5	17.2	19.5
	50	17.6	19.2	21.1	24.6	28.5	14.9	16.4	18.0	20.7	24.2
	60	20.7	22.7	25.0	29.3	33.6	18.0	19.5	21.1	24.6	28.5

SI: 1 in = 25.4 mm, 1 mph = 1.61 km/h

- Linear interpolation is permitted.
- DRYline® SIX Structural Insulation Board installed with butted joints on 2x4 studs spaced 16" o.c. and fastened as follows with spacing 3" o.c. along the edges and 3" o.c. in the field. Fastener edge distance shall be a minimum of 3/8".
 - DRYline® SIX Structural Insulation Board R3: "N"-style 16-gauge galvanized staple (1/2" crown x 1 1/4" leg), or 1" crown x 1 1/4" leg
 - DRYline® SIX Structural Insulation Board R5: 16-gauge galvanized staple (1" crown x 2" leg)
- Demonstrates equivalency to IRC Table R602.10.3(1). All adjustment factors from IRC Table R602.10.3(2) shall be applied.
- Minimum 1/2" gypsum wallboard shall be installed as part of the wall assembly. Where gypsum wallboard is not applied to the interior side of the wall assembly, bracing lengths shall be multiplied by a factor of 1.4.
- Bracing lengths are the result of comparative equivalency testing and analysis using both tested and published design values as points of comparison. DrJ relies upon the design values published in the codes and standards listed in Section 4 that are adopted into law and that the manufacturers of those products stand behind. DrJ performs all equivalency analysis based on legally defined design values, the responsibility for which is the manufacturer of those products or the members of the associations that publish those design values.
- Wind speeds are V_{ult} in accordance with ASCE 7-22. Use V_{asd} = V_{ult}√0.6. to convert to equivalent V_{asd} wind speed in accordance with IBC Section 1609.3.1.

6.11.3 DRYline® SIX Structural Insulation Board Method CS-PF – Continuously Sheathed Portal Frame:

6.11.3.1 A "DRYline® SIX Structural Insulation Board Structural Sheathing CS-PF" was evaluated for use in IRC Method CS-PF in accordance with IRC Section R602.10.6.4 and IRC Table R602.10.6.4 and is approved for use as a contributing length of wall bracing in accordance with IRC Section R602.10.5.

6.11.3.2 The DRYline® SIX Structural Insulation Board Structural Sheathing CS-PF is described as follows in **Figure 2** and **Figure 3**.

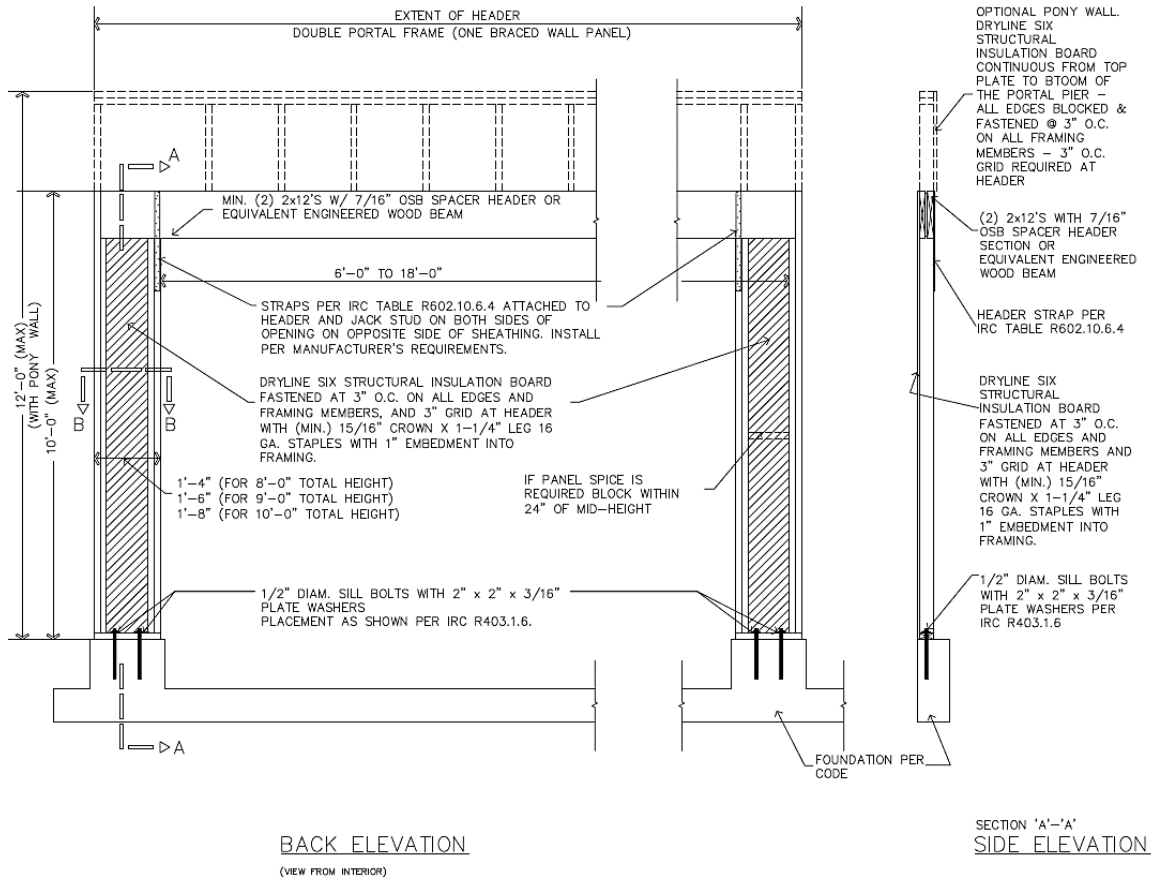

Figure 2. DRYline® SIX Structural Insulation Board Structural Sheathing CS-PF

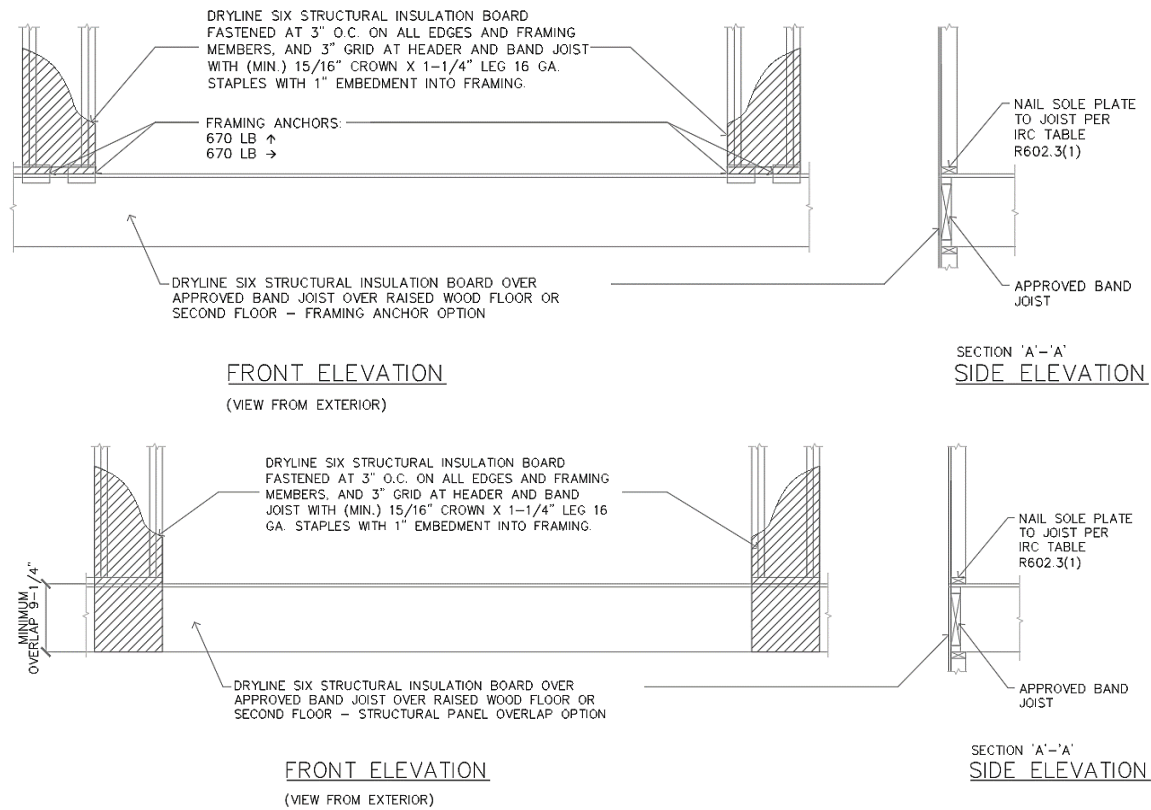

Figure 3. DRYline® SIX Structural Insulation Board Structural Sheathing CS-PF (Anchorage Details)

6.11.4 *DRYline® SIX Structural Insulation Board Method PFH – Portal Frame with Hold Downs:*

- 6.11.4.1 In accordance with the IRC Section R602.10.6.2, the PFH referenced in the IRC is permitted to be an equivalent replacement for a 4' length of Method WSP bracing.
- 6.11.4.2 The DRYline® SIX Structural Insulation Board Structural Sheathing 12" PFH and 24" PFH is constructed in accordance with **Figure 4**, **Figure 5**, and **Figure 6**.

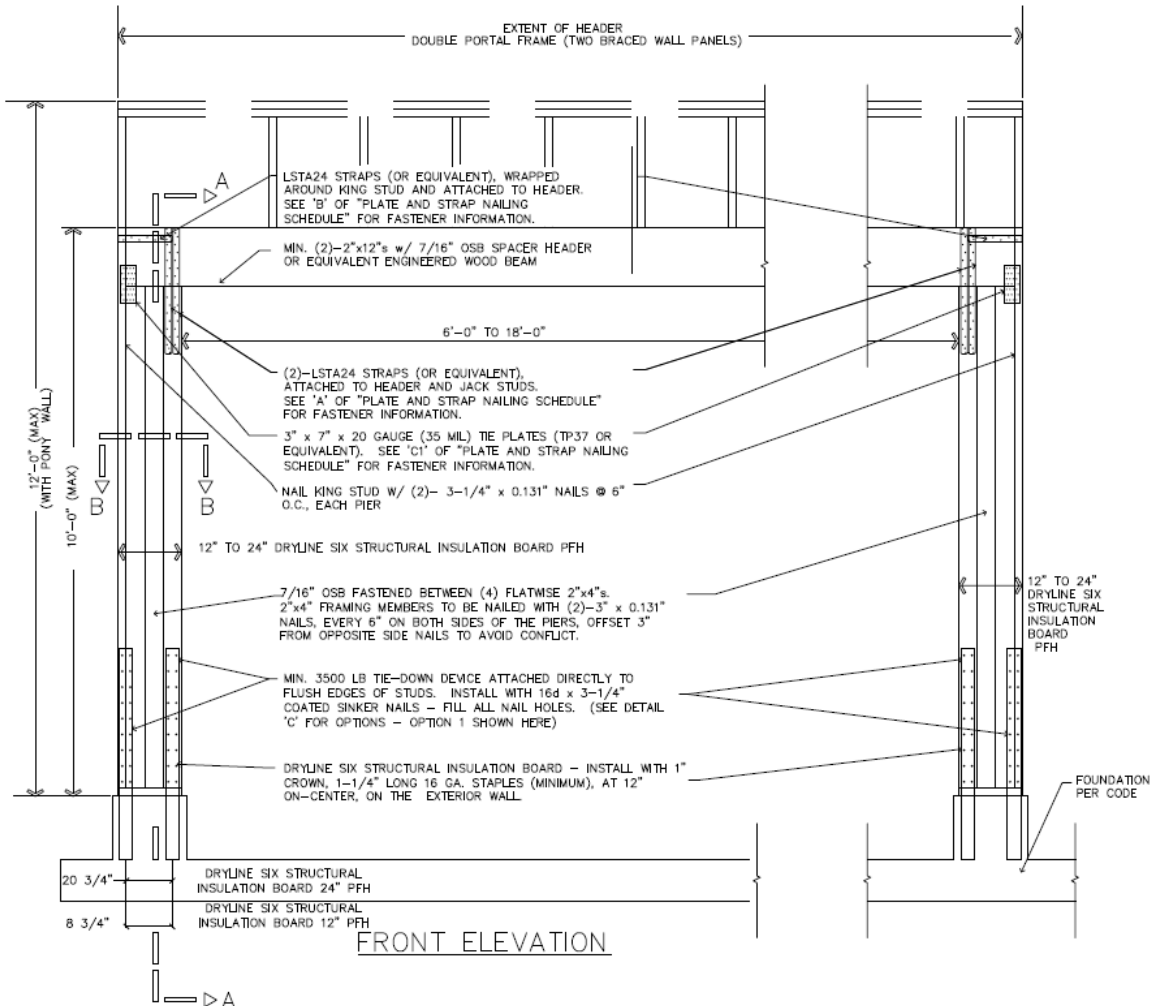

PLATE AND STRAP NAILING SCHEDULE

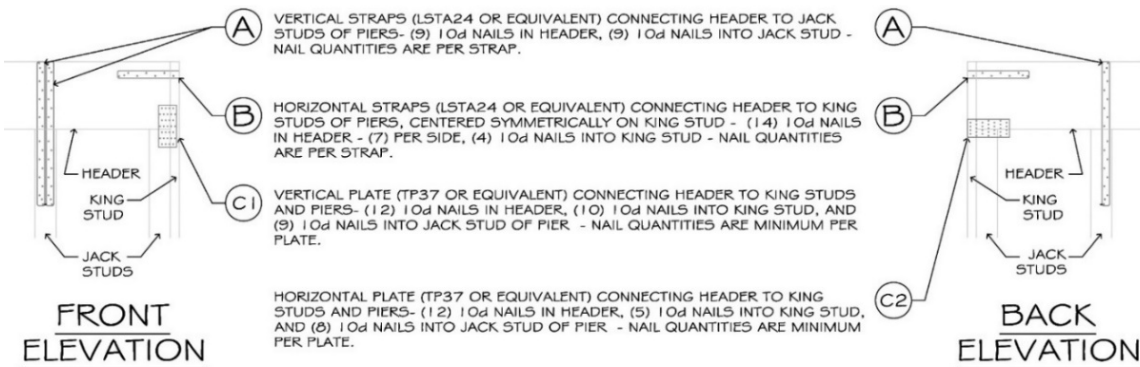

Figure 4. Construction Details of DRYline® SIX Structural Insulation Board 12" to 24" PFH

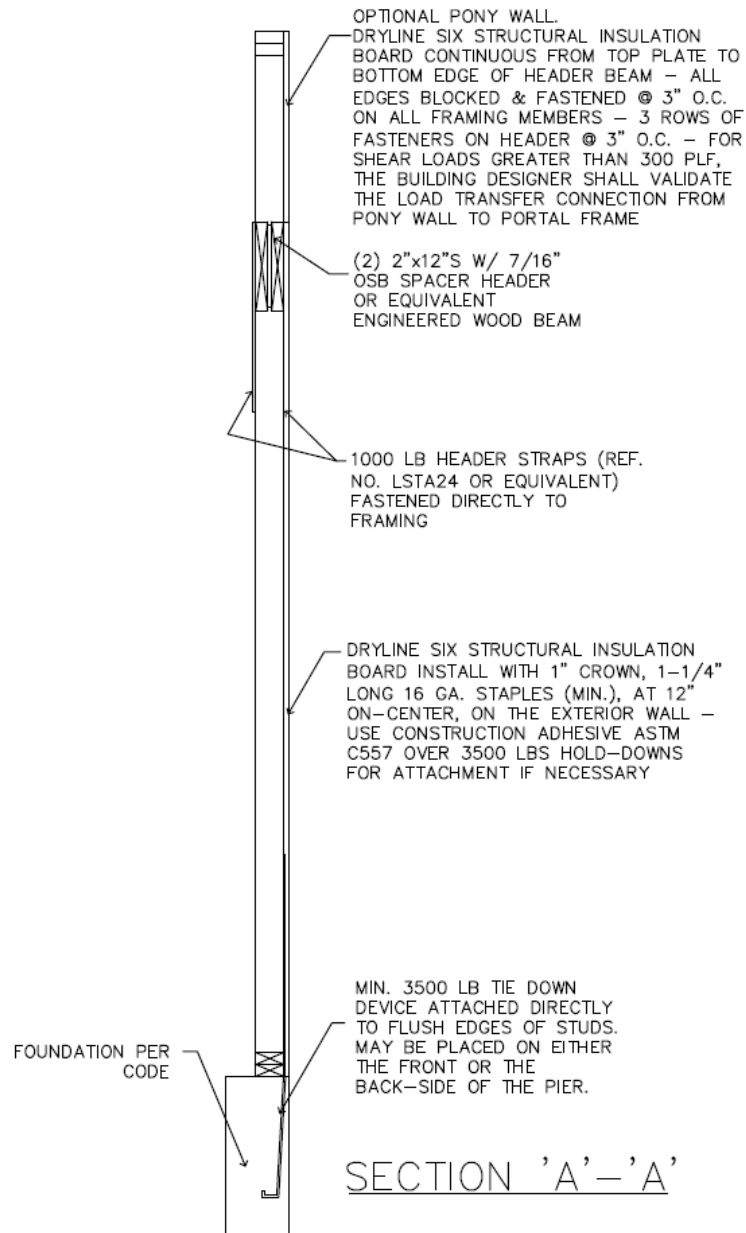

Figure 5. DRYline® SIX Structural Insulation Board 12" to 24" PFH Section A-A

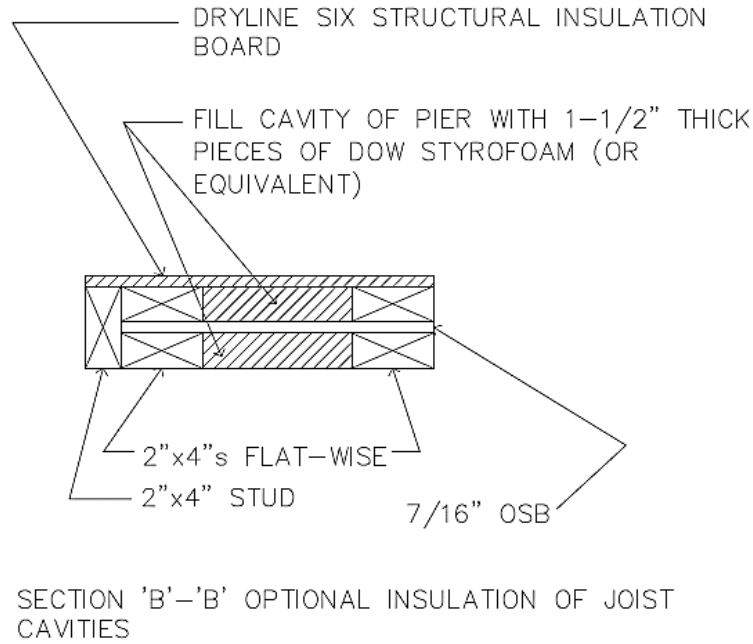

Figure 6. DRYline® SIX Structural Insulation Board 12" to 24" PFH Section B-B (Portal Pier Assembly)

6.11.4.3 A comparison of WSP braced wall, and DRYline® SIX Structural Insulation Board 12" PFH and 24" PFH is shown in **Table 6**.

Table 6. ASD Allowable Design Values for PFH^{1,2,3,4}

Test Name	Sheathing Material	Fastener Size and Spacing	Total Bracing Width (in)	Maximum Wall Height (ft)	ASD Allowable Design Value per Panel/Pier (lb) (wind)
IBC/IRC Benchmark	3/8" OSB isolated 4'x8' panels	2 3/8" x 0.113" nails at 6:12 spacing	96	≤ 10	1,400
12" PFH	DRYline® SIX Structural Insulation Board	see Figure 4, Figure 5 and Figure 6	12	8	1,410
				10	1,060
24" PFH	DRYline® SIX Structural Insulation Board	see Figure 4, Figure 5 and Figure 6	24	8	2,560
				10	1,920

SI: 1 in = 25.4 mm, 1 lb = 4.45 N

- Capacity derived from multiple full-scale tests constructed with SPF framing, as well as testing from other labs, showing the capacity of OSB sheathing in buildings constructed in accordance with the minimum requirements of the IRC.
- The PFH bracing type in the IBC/IRC is defined as equivalent to a 4' BWP using 3/8" WSP. Equivalent capacity is based on comparison testing of the PFH and 3/8" OSB as compared to the published capacities as defined in the IBC and SDPWS.
- Interpolation between the wall heights and pier widths for the 12" PFH and 24" PFH is permitted.
- 10' high wall design values are provided here that use a seventy-five percent (75%) factor to reduce the 8' high wall design values generated by test data.



6.11.4.4 The test data and subsequent engineering analysis provides confirmation that the performance of the DRYline® SIX Structural Insulation Board 12" PFH and 24" PFH provide comparable equivalence to the Method WSP braced wall panels.

6.11.4.5 The maximum allowable compressive strength of the DRYline® SIX Structural Insulation Board 12" to 24" PFH is 11,156 lbs. per pier based on five SPF studs per pier (detailed in **Figure 4**, **Figure 5** and **Figure 6**). Additional compressive capacity may be engineered into each pier. Structurally attaching full-height framing members within the pier cavity is one possible engineered option.

6.11.5 *Alternative Prescriptive IRC Wall Bracing Applications:*

6.11.5.1 As an alternative to Section 6.11.1, the following provisions are permitted:

- 6.11.5.1.1 DRYline® SIX Structural Insulation Board may be used to brace walls of buildings as an alternative to the WSP and CS-WSP provisions of IRC Section R602.10.4, when installed in accordance with this report.
- 6.11.5.1.2 These braced wall line length equivalency factors (**Table 7**) are based on equivalency testing and are used to comply with Method WSP and CS-WSP of the IRC.
- 6.11.5.1.3 Required braced wall panel lengths for DRYline® SIX Structural Insulation Board shall be as determined by multiplying the equivalency factor shown in **Table 7** by the lengths in IRC Table R602.10.3(1) as modified by all applicable factors in IRC Table R602.10.3(2). All IRC footnotes shall apply.

Table 7. Braced Wall Line Length Equivalency Factor^{1,2,3,4,5,6}

Wall Assembly	Orientation (in)	Fastener(s)	Fastener Spacing (in)	Max. Stud Spacing (in)	Equivalency Factor to IRC WSP and CS-WSP
DRYline® SIX Structural Insulation Board R3	Foam In	1¾" x 0.120" nail ⁷	3:3	16 o.c.	0.86
	Foam Out	"N"-style 16-gauge galvanized staple ½" crown x 1½" leg, or 1" crown x 1½" leg			0.78
DRYline® SIX Structural Insulation Board R5	Foam In	1¾" x 0.120" nail ⁷			0.94
	Foam Out	16-gauge galvanized staple, 1" crown x 2" leg			0.78

SI: 1 in = 25.4 mm

1. Gypsum sheathing installed with Type W screws at 8":8" spacing.
2. Multiply the bracing lengths in IRC Table R602.10.3(1) and IRC Table R602.10.3(2) Method WSP or CS-WSP as applicable, including all footnotes, by the factors shown here to establish the required bracing length.
3. Where gypsum wallboard is not applied to the interior side of the DRYline® SIX Structural Insulation Board assembly, bracing lengths shall be multiplied by a factor of 1.4.
4. Valid for single and double top plate DRYline® SIX Structural Insulation Board installations.
5. Factors based on SPF framing materials.
6. These braced wall line length equivalency factors are based on equivalency testing and are used to comply with Method WSP and CS-WSP of the IRC.
7. Nails with a head diameter and length greater than the 1¾" x 0.120" nails are also permissible.

6.11.6 *Prescriptive IBC Conventional Light-Frame Wood Construction:*

6.11.6.1 DRYline® SIX Structural Insulation Board may be used to brace exterior walls of buildings as an equivalent alternative to WSP or CS-WSP bracing methods of the IBC when installed with blocked or unblocked ½" gypsum fastened with a minimum #6 Type W screw spaced a maximum of 8" o.c. at panel edges and 8" o.c. in the field. Bracing shall be in accordance with the conventional light-frame construction method of IBC Section 2308.6 and this report.



6.11.7 Performance-Based IBC Wood-Framed Construction:

6.11.7.1 DRYline® SIX Structural Insulation Board panels used in wall assemblies designed as shear walls are approved for the following applications:

- 6.11.7.1.1 Design in accordance with the methodology used in SDPWS for WSP using the capacities shown in **Table 8**.
- 6.11.7.1.2 Resistance to lateral wind load forces using the allowable shear loads (in pounds per linear foot) set forth in **Table 8**.
- 6.11.7.1.3 Resistance to transverse wind load forces using the allowable transverse loads (in pounds per square foot) set forth in **Table 9**. The transverse wind load forces correspond to the allowable basic wind speeds in **Table 10**.

Table 8. Allowable Stress Design (ASD) Capacity for Wind¹

Product	Foam Board Orientation	Fastener(s) Schedule ²	Fastener Spacing (edge:field) (in)	Maximum Stud Spacing (in)	Gypsum Wallboard ³ (GWB)	Gypsum Wallboard ³ Fastener Spacing (edge:field) (in)	Allowable Unit Shear Capacity (plf)		
DRYline® SIX Structural Insulation Board R3	Foam In	1 ³ / ₄ " x 0.120" smooth shank nail ⁴	3:3	16 o.c.	None	-	260		
	Foam Out	"N"-style 16-gauge galvanized staple 1/2" crown x 1 ¹ / ₄ " leg, or 1" crown x 1 ¹ / ₄ " leg			1/2" GWB	8:8	360		
					None	-	295		
	Foam Out	16-gauge galvanized staple, 1" crown x 2" leg			1/2" GWB	8:8	395		
None					-	230			
DRYline® SIX Structural Insulation Board R5	Foam In	1 ³ / ₄ " x 0.120" ring shank nail			3:3	16 o.c.	1/2" GWB	8:8	330
	Foam Out	16-gauge galvanized staple, 1" crown x 2" leg					None	-	300
							1/2" GWB	8:8	400
	Foam Out	16-gauge galvanized staple, 1" crown x 2" leg	None	-			300		
1/2" GWB			8:8	400					

SI: 1 in = 25.4 mm, 1 lb/ft = 0.0146 kN/m

1. Tested in accordance with ASTM E564.
2. DRYline® SIX Structural Insulation Board installed with butted joints on 2x4 studs spaced 16" o.c. and fastened as follows with spacing 3" o.c. along the edges and 3" o.c. in the field. Fastener edge distance shall be a minimum of 3/8".
3. Gypsum attached with minimum #6 type W or S screws 1¹/₄" long
4. Nails with a head diameter and length greater than the 1³/₄" x 0.120" nails are also permissible.

Table 9. Transverse (Out-Of-Plane) Wind Load Resistance^{1,2,3}

Product	Maximum Stud Spacing (in)	Fastener Schedule	Allowable Design Value (psf)
DRYline® SIX Structural Insulation Board	16 o.c.	1" crown, 1 ¹ / ₄ " leg, 16-gauge galvanized staples, 3":3" o.c. spacing (edge:field)	120

SI: 1 in = 25.4 mm, 1 psf = 0.0479 kN/m²

1. Tested in accordance with ASTM E330.
2. The capacities shown are for the purpose of providing information on the hold-down capacity of the sheathing to the bottom plate connection independent of lateral loading. Where combined shear and uplift loading is needed, consult a professional engineer.
3. Applicable to both the positive and negative direction.



Table 10. Basic Wind Speed for Use in Exterior Wall Covering Assemblies^{1,2}

Product	Allowable Components & Cladding Basic Wind Speed (mph)	
	ASCE 7-05 (V_{asd})	ASCE 7-16 and 7-22 (V_{ult})
DRYline® SIX Structural Insulation Board	155	200

SI: 1 mph = 1.61 km/h

- Allowable wind speeds are based on the following: Mean roof height 30', Exposure B, Zone 5, 10 sq. ft. effective wind area. See the applicable building code for any adjustment need for specific building location and configuration.
- 16" o.c. framing

6.12 Thermal Insulation

6.12.1 DRYline® SIX Structural Insulation Board meets the continuous insulation requirements of [IECC Section C402](#) and [IECC Section R402](#) and has the thermal resistance provided in **Table 11**.

Table 11. Thermal Resistance Properties¹

Product	R-Value (F-ft ² -hr/Btu)
DRYline® SIX Structural Insulation Board R3	3.0
DRYline® SIX Structural Insulation Board R5	5.0

- Components tested in accordance with ASTM C518.

6.13 Water-Resistive Barrier (WRB)

- 6.13.1 DRYline® SIX Structural Insulation Board may be used as a WRB as prescribed in [IBC Section 1403.2^{xxi}](#) and [IRC Section R703.2](#) when installed with foam facing in on exterior walls as described in this section.
- 6.13.2 DRYline® SIX Structural Insulation Board installed with the foam facing out shall be covered with a code-compliant WRB in accordance with [IBC Section 1403.2^{xxii}](#) and [IRC Section R703.2](#).
- 6.13.3 DRYline® SIX Structural Insulation Board shall be installed with board joints placed directly over exterior framing spaced a maximum of 16" (610 mm) o.c. The fasteners used to attach the board shall be installed in accordance with **Table 1** through **Table 8** and Section **9** as applicable.
- 6.13.4 A separate WRB may also be provided. If a separate WRB method is used, sealing of the sheathing joints is not required.
- 6.13.5 All seams and joints between boards shall be overlapped 3/4" (19 mm) or covered by minimum 1 1/2" (38 mm) wide DRYline® Sheathing Tape, or approved equal.
- 6.13.6 Flashing must be installed at all sheathing penetrations and shall comply with all the applicable code sections.
- 6.13.7 DRYline® SIX Structural Insulation Board may be installed as a WRB in a non-structural capacity with the fasteners used to attach the board installed in accordance with Section **6.17**.
- 6.13.8 All joints between sheathing panels shall be covered by minimum 1 1/2" (38 mm) wide tape (DRYline® Sheathing Tape or equivalent).

6.14 Vapor Retarder

6.14.1 DRYline® SIX Structural Insulation Board is a Class II [vapor retarder](#) in accordance with [IBC Section 1404.3](#) and as shown in **Table 12**.



Table 12. Water Vapor Barrier Properties¹

Product	Water Vapor Transmission (perm)
DRYline® SIX Structural Insulation Board	0.3
1. Tested in accordance with ASTM E96, Desiccant Method.	

6.15 Air Barrier

- 6.15.1 DRYline® SIX Structural Insulation Board meets the requirements of IRC Section N1102.4.1.1 and IECC Section C402.5.1.3 for use as a component of the air barrier when installed in accordance with the manufacturer installation instructions and this report (**Table 13**).
- 6.15.2 When used as part of a continuous air barrier assembly, DRYline® SIX Structural Insulation Board shall be installed in accordance with Section 9. When installed as part of a continuous air barrier in a non-structural capacity, the fasteners used to attach the board may be installed in accordance with Section 6.17.
- 6.15.3 All sheathing panel edges at the top and bottom of wall assemblies, and all joints between sheathing panels, shall be sealed in accordance with IRC Section N1102.4.1.1, IECC Section R402.4.1.1 and IECC Section C402.5.1.
- 6.15.4 All joints between sheathing panels shall be covered by minimum 1½" (38 mm) wide tape (DRYline® Sheathing Tape or equivalent).

Table 13. Air Barrier Properties¹

Product	Air Permeability (cfm/ft ²)
DRYline® SIX Structural Insulation Board	< 0.004
1. Tested in accordance with ASTM E2178.	

6.16 Surface Burning Characteristics

- 6.16.1 DRYline® SIX Structural Insulation Board has the flame spread and smoke developed characteristics shown in **Table 14** when tested in accordance with ASTM E84 per IBC Section 2603.3.

Table 14. Surface Burn Characteristics¹

Product	Flame Spread	Smoke Developed	Classification
DRYline® SIX Structural Insulation Board	≤ 25	≤ 450	Class A
1. Tested in accordance with ASTM E84.			

6.17 Minimum Fastening Requirements for Non-Structural Applications

- 6.17.1 Where other means of wall bracing are provided or are not required, and an approved exterior wall covering capable of separately resisting loads perpendicular to the face of the walls is installed over the sheathing, DRYline® SIX Structural Insulation Board may be used.
- 6.17.2 The sheathing panels are applied to wall framing with minimum 0.120" x 1¼" (3 mm x 32 mm) galvanized roofing nails or 16-gauge galvanized staples having a 7/16" (11 mm) crown and 1¼" (32 mm) leg lengths.



- 6.17.3 Fastener spacing shall be a maximum of 6" (152 mm) at the edges and 12" (305 mm) on intermediate members.
 - 6.17.3.1 Stud spacing shall be a maximum of 24" (610 mm) o.c.
 - 6.17.3.2 Minimum fastener penetration into the framing members is 3/4" (19 mm).
- 6.18 Where the application falls outside of the performance evaluation, conditions of use and/or installation requirements set forth herein, alternative techniques shall be permitted in accordance with accepted engineering practice and experience. This includes but is not limited to the following areas of engineering: mechanics or materials, structural, building science and fire science.

7 Certified Performance^{xxiii}

- 7.1 All construction methods shall conform to accepted engineering practices to ensure durable, livable and safe construction and shall demonstrate acceptable workmanship reflecting journeyman quality of work of the various trades.^{xxiv}
- 7.2 The strength and rigidity of the component parts and/or the integrated structure shall be determined by engineering analysis or by suitable load tests to simulate the actual loads and conditions of application that occur.^{xxv}

8 Regulatory Evaluation and Accepted Engineering Practice

- 8.1 DRYline® SIX Structural Insulation Board comply with the following legislatively adopted regulations and/or accepted engineering practice for the following reasons:
 - 8.1.1 Structural performance under lateral load conditions for wind loading for use as an alternative to the IRC Intermittent Wall Bracing provisions of [IRC Section R602.10](#) Wood Structural Panel (WSP) method.
 - 8.1.2 Structural performance under lateral load conditions for wind loading for use with the IRC Continuous Wall Bracing provisions of [IRC Section R602.10.4](#) Continuously Sheathed Wood Structural Panel (CS-WSP) and Continuously Sheathed Portal Frame (CS-PF) methods.
 - 8.1.3 Structural performance under lateral load conditions for use as an alternative to the IRC Continuous Wall Bracing provisions of [IRC Section R602.10.6.2](#) Portal Frame with Hold-downs (PFH) method.
 - 8.1.4 Structural performance under lateral load conditions for wind loading for use with the IBC performance-based provisions [IBC Section 2306.1](#) and [IBC Section 2306.3](#) for light-frame wood wall assemblies.
 - 8.1.5 Structural performance under lateral load conditions for use as an alternative to the IRC simplified bracing provisions of [IRC Section R602.12](#).
 - 8.1.6 Structural performance under lateral load conditions for use as an alternative to SDPWS Section 4.3 Wood-Frame Shear Walls.
 - 8.1.7 Resistance to transverse loads for wall assemblies used in light-frame wood construction in accordance with [IBC Section 1609.1.1](#) and [IRC Section R301.2.1](#).
 - 8.1.8 Performance for use as insulated sheathing in accordance with the [IECC Section C402.1](#) and [IECC Section R402.1](#).
 - 8.1.9 Performance for use as a water-resistive barrier (WRB) in accordance with the [IBC Section 1403.2^{xxvi}](#) and [IRC Section R703.2](#).
 - 8.1.10 Performance for use as a vapor retarder in accordance with [IBC Section 202](#), [IBC Section 1404.3^{xxvii}](#), [IRC Section R202](#) and [IRC Section R702.7](#).
 - 8.1.11 Performance for use as an air barrier in accordance with [IRC Section N1102.4.1.1](#) and [IECC Section C402.5.1.3^{xxviii}](#).
 - 8.1.12 Surface burning characteristics in accordance with [IBC Section 2603.3](#) and [IRC Section R316.3](#).



- 8.2 Performance under seismic loading is outside the scope of this report.
- 8.3 Use of design values for buildings exempt from seismic loading provisions in IBC Section 1613.1 is permitted. For buildings designed in accordance with the IRC, use in Seismic Design Categories (SDC) A, B, and C for detached dwellings and in SDC A and B for townhouses is permitted using the wind bracing design provisions in accordance with IRC Table R602.10.1.3.
- 8.4 Use with steel studs is outside the scope of this report.
- 8.5 Any building code, regulation and/or accepted engineering evaluations (i.e., research reports, duly authenticated reports, etc.) that are conducted for this Listing were performed by DrJ Engineering, LLC (DrJ), an ISO/IEC 17065 accredited certification body and a professional engineering company operated by RDP/approved sources. DrJ is qualified^{xxx} to practice product and regulatory compliance services within its scope of accreditation and engineering expertise, respectively.
- 8.6 Engineering evaluations are conducted with DrJ's ANAB accredited ICS code scope of expertise, which are also its areas of professional engineering competence.
- 8.7 Any regulation specific issues not addressed in this section are outside the scope of this report.

9 Installation

- 9.1 Installation shall comply with the approved construction documents, the manufacturer installation instructions, this report and the applicable building code.
- 9.2 In the event of a conflict between the manufacturer installation instructions and this report, the more restrictive shall govern.
- 9.3 Fasteners shall conform to those listed in **Table 1** through **Table 8** and Section **6.17**, as applicable.
- 9.4 Always fasten staples parallel to the framing member.
- 9.5 Fasteners shall be installed with a minimum edge distance of $\frac{3}{8}$ ".
- 9.6 For joints butted at framing members, a single row of fasteners must be applied to each panel edge into the stud.
- 9.7 *Installation Procedure*
 - 9.7.1 Fasten DRYline® SIX Structural Insulation Board in the order shown in **Figure 7** through **Figure 11**. Do not fasten the four corners first.
 - 9.7.2 Do not tack DRYline® SIX Structural Insulation Board to framing, but fasten each panel completely once fastening begins.
 - 9.7.3 *Step 1:*
 - 9.7.3.1 Starting at the top corner, fasten down the full length of the framing member every 3" using approved staples or nails. All perimeter edges must be installed over framing members and fastened for structural use.
 - 9.7.3.2 All fasteners shall penetrate at least 1" (**Figure 7**).

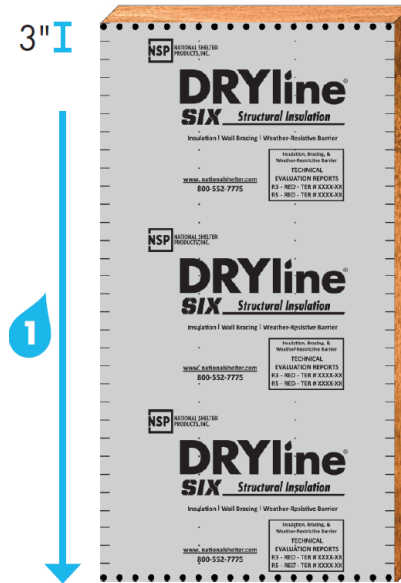

Figure 7. Installation, Step 1

9.7.4 Step 2:

- 9.7.4.1 Begin nailing pattern across the top (2A) and bottom (2B) of the panel from Step 1 until you reach the next stud (Figure 8). All fasteners shall penetrate at least 1".
- 9.7.4.2 Starting at the top, fasten down the full length of the framing member (3) every 3" using approved staples or nails (Figure 8). All fasteners shall penetrate at least 1".

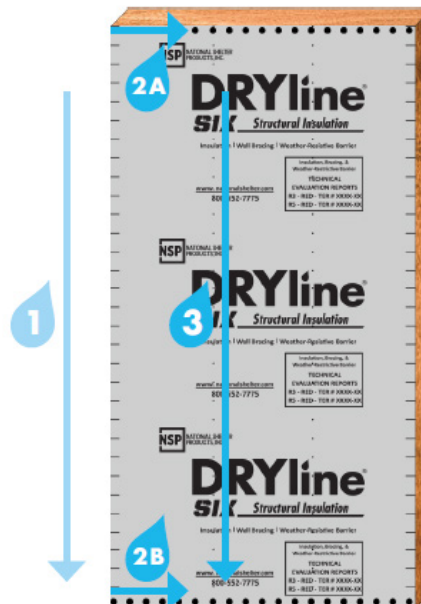

Figure 8. Installation, Step 2

9.7.5 Steps 3-4:

- 9.7.5.1 Repeat "Step 2:" on sequential studs remaining in panel (Figure 9 and Figure 10).

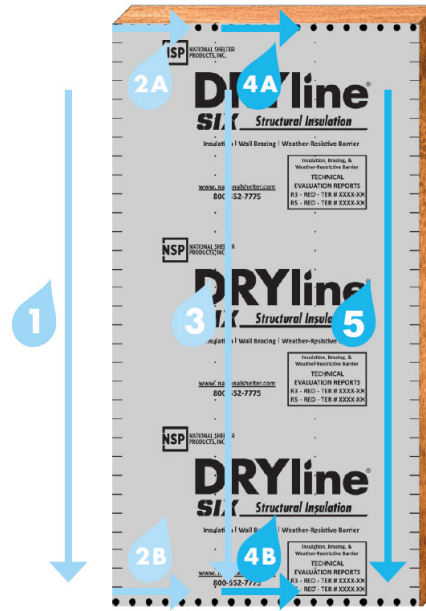

Figure 9. Installation, Step 3



Figure 10. Installation, Step 4

9.7.6 Step 5:

9.7.6.1 To achieve a WRB, all seams must be taped in shingle fashion.

9.7.6.2 Use DRYline® Sheathing Tape, or approved equivalent. Seams must be dry and clear of debris (Figure 11).



Figure 11. Installation, Step 5

10 Substantiating Data

- 10.1 Testing has been performed under the supervision of a professional engineer and/or under the requirements of ISO/IEC 17025 as follows:
 - 10.1.1 Lateral wall testing performed in accordance with ASTM E564
 - 10.1.2 Transverse wind pressure resistance testing performed in accordance with ASTM E330
 - 10.1.3 Material property testing for Neopor® in accordance with ASTM C578
 - 10.1.4 Water-resistive barrier testing conducted in accordance with ASTM E331
 - 10.1.5 Water vapor transmission testing performed in accordance with ASTM E96
 - 10.1.6 Air barrier testing performed in accordance with ASTM E2178
 - 10.1.7 Surface burning characteristics testing performed in accordance with ASTM E84
- 10.2 Information contained herein may include the result of testing and/or data analysis by sources that are approved agencies, approved sources and/or RDPs. Accuracy of external test data and resulting analysis is relied upon.
- 10.3 Where pertinent, testing and/or engineering analysis are based upon provisions that have been codified into law through state or local adoption of regulations and standards. The developers of these regulations and standards are responsible for the reliability of published content. DrJ's engineering practice may use a regulation-adopted provision as the control. A regulation-endorsed control versus a simulation of the conditions of application to occur establishes a new material as being equivalent to the regulatory provision in terms of quality, strength, effectiveness, fire resistance, durability and safety.



- 10.4 The accuracy of the provisions provided herein may be reliant upon the published properties of raw materials, which are defined by the grade mark, grade stamp, mill certificate, or duly authenticated reports from approved agencies and/or approved sources provided by the supplier. These are presumed to be minimum properties and relied upon to be accurate. The reliability of DrJ's engineering practice, as contained in this duly authenticated report, may be dependent upon published design properties by others.
- 10.5 Testing and engineering analysis: The strength, rigidity and/or general performance of component parts and/or the integrated structure are determined by suitable tests that simulate the actual conditions of application that occur and/or by accepted engineering practice and experience.^{xxx}
- 10.6 Where additional condition of use and/or regulatory compliance information is required, please search for DRYline® SIX Structural Insulation Board on the DrJ Certification website.

11 Findings

- 11.1 As outlined in Section 6, DRYline® SIX Structural Insulation Board have performance characteristics that were tested and/or meet applicable regulations and are suitable for use pursuant to its specified purpose.
- 11.2 When used and installed in accordance with this duly authenticated report and the manufacturer installation instructions, DRYline® SIX Structural Insulation Board shall be approved for the following applications:
 - 11.2.1 Use as an alternative to the WSP and CS-WSP wall bracing in accordance with IRC Section R602.10.
 - 11.2.2 Use to resist wind loading in accordance with the IBC performance-based provisions, IBC Section 2306.1 and IBC Section 2306.3 for light-frame wood wall assemblies.
 - 11.2.3 Use to resist transverse loads on wall assemblies used in light-frame wood construction in accordance with IBC Section 1609.1.1 and IRC Section R301.2.1.
 - 11.2.4 Use as insulated sheathing in accordance with the IRC Section N1102.4.1.1 and IECC Section C402.1.
 - 11.2.5 Use as a WRB in accordance with the IBC Section 1403.2^{xxx} and IRC Section R703.2.
 - 11.2.6 Use as a Class II vapor retarder in accordance with IBC Section 1404.3.
 - 11.2.7 Use as an air barrier in accordance with the IRC Section N1102.4.1.1 and IECC Section C402.5.1.3^{xxxii}.
- 11.3 Unless exempt by state statute, when DRYline® SIX Structural Insulation Board are to be used as a structural and/or building envelope component in the design of a specific building, the design shall be performed by an RDP.
- 11.4 Any application specific issues not addressed herein can be engineered by an RDP. Assistance with engineering is available from National Shelter Products, Inc.
- 11.5 IBC Section 104.11 (IRC Section R104.11 and IFC Section 104.10^{xxxiii} are similar) in pertinent part states:

104.11 Alternative materials, design and methods of construction and equipment. The provisions of this code are not intended to prevent the installation of any material or to prohibit any design or method of construction not specifically prescribed by this code. Where the alternative material, design or method of construction is not approved, the building official shall respond in writing, stating the reasons the alternative was not approved.

- 11.6 **Approved:**^{xxxiv} Building regulations require that the building official shall accept duly authenticated reports.^{xxxv}
 - 11.6.1 An approved agency is "approved" when it is ANAB ISO/IEC 17065 accredited.
 - 11.6.2 An approved source is "approved" when an RDP is properly licensed to transact engineering commerce.
 - 11.6.3 Federal law, Title 18 US Code Section 242, requires that where the alternative product, material, service, design, assembly and/or method of construction is not approved, the building official shall respond in writing, stating the reasons why the alternative was not approved. Denial without written reason deprives a protected right to free and fair competition in the marketplace.



- 11.7 DrJ is a licensed engineering company, employs licensed RDPs and is an ANAB-Accredited Product Certification Body – Accreditation #1131.
- 11.8 Through the IAF Multilateral Agreements (MLA), this Duly Authenticated Report can be used to obtain product approval in any jurisdiction or country because all ANAB ISO/IEC 17065 Duly Authenticated Reports are equivalent.^{xxxvi}

12 Conditions of Use

- 12.1 Material properties shall not fall outside the boundaries defined in Section 6.
- 12.2 As defined in Section 6, where material and/or engineering mechanics properties are created for load resisting design purposes, the resistance to the applied load shall not exceed the ability of the defined properties to resist those loads using the principles of accepted engineering practice.
- 12.3 As listed herein, DRYline® SIX Structural Insulation Board shall not be used:
- 12.3.1 As a nailing base for claddings, trim, windows, or doors. Fastening through the DRYline® SIX Structural Insulation Board into the framing is acceptable.
 - 12.3.2 To resist horizontal loads from concrete and masonry walls. When used behind masonry, devices such as masonry ties shall be used to transfer the load to the main force resisting system.
- 12.4 When used as part of a continuous air barrier assembly, all sheathing panel edges at the top and bottom of the wall assemblies and all joints between sheathing panels shall be sealed with an approved construction tape.
- 12.5 When DRYline® SIX Structural Insulation Board is installed as a wall sheathing but is not installed per structural requirements, light-framed walls shall be braced by other means. When used as a WRB, installation shall be in accordance with Section 6.13 of this report.
- 12.6 When DRYline® SIX Structural Insulation Board is not installed as a WRB, other means of providing a WRB are required, as per the code.
- 12.7 When used in accordance with the IBC in high wind areas, special inspections shall comply with IBC Section 1705.12.^{xxxvii}
- 12.8 Design loads shall be determined in accordance with the building code adopted by the jurisdiction in which the project is to be constructed.
- 12.8.1 Allowable shear loads shall not exceed the values in **Table 8** for wind loads.
 - 12.8.2 Transverse design loads shall not exceed those described in **Table 9**, unless an approved exterior wall covering capable of separately resisting loads perpendicular to the face of the walls is installed over the sheathing.
 - 12.8.3 Allowable wind speeds do not exceed values in **Table 10**.
- 12.9 All panel edges shall be supported by wall framing or solid blocking a minimum of 2" (51 mm) nominal in thickness.
- 12.10 When required by adopted legislation and enforced by the building official, also known as the authority having jurisdiction (AHJ) in which the project is to be constructed:
- 12.10.1 Any calculations incorporated into the construction documents shall conform to accepted engineering practice and, when prepared by an approved source, shall be approved when signed and sealed.
 - 12.10.2 This report and the installation instructions shall be submitted at the time of permit application.
 - 12.10.3 These innovative products have an internal quality control program and a third-party quality assurance program.
 - 12.10.4 At a minimum, these innovative products shall be installed per Section 9 of this report.
 - 12.10.5 The review of this report by the AHJ shall comply with IBC Section 104 and IBC Section 105.4.
 - 12.10.6 These innovative products have an internal quality control program and a third party quality assurance program in accordance with IBC Section 104.4, IBC Section 110.4, IBC Section 1703, IRC Section R104.4 and IRC Section R109.2.



- 12.10.7 The application of these innovative products in the context of this report, is dependent upon the accuracy of the construction documents, implementation of installation instructions, inspection as required by IBC Section 110.3, IRC Section R109.2 and any other regulatory requirements that may apply.
- 12.11 The approval of this report by the AHJ shall comply with IBC Section 1707.1, where legislation states in part, “*the building official shall accept duly authenticated reports from approved agencies in respect to the quality and manner of use of new material or assemblies as provided for in Section 104.11*”, all of IBC Section 104 and IBC Section 105.4.
- 12.12 Design loads shall be determined in accordance with the regulations adopted by the jurisdiction in which the project is to be constructed and/or by the building designer (i.e., owner or RDP).
- 12.13 The actual design, suitability and use of this report for any particular building, is the responsibility of the owner or the authorized agent of the owner.

13 Identification

- 13.1 The innovative products listed in Section 1.1 are identified by a label on the board or packaging material bearing the manufacturer name, product name, this report number and other information to confirm code compliance.
- 13.2 Additional technical information can be found at www.nationalshelter.com.

14 Review Schedule

- 14.1 This report is subject to periodic review and revision. For the latest version, visit drjcertification.org.
- 14.2 For information on the status of this report, please contact [DrJ Certification](#).

15 Approved for Use Pursuant to U.S. and International Legislation Defined in Appendix A

- 15.1 DRYline® SIX Structural Insulation Boards are included in this report published by an approved agency that is concerned with evaluation of products or services, maintains periodic inspection of the production of listed materials or periodic evaluation of services. This report states either that the material, product, or service meets recognized standards or has been tested and found suitable for a specified purpose. This report meets the legislative intent and definition of being acceptable to the AHJ.



Appendix A

1 Legislation that Authorizes AHJ Approval

- 1.1 **Fair Competition:** State legislatures have adopted Federal regulations for the examination and approval of building code referenced and alternative products, materials, designs, services, assemblies and/or methods of construction that:
 - 1.1.1 Advance Innovation,
 - 1.1.2 Promote competition so all businesses have the opportunity to compete on price and quality in an open market on a level playing field unhampered by anticompetitive constraints, and
 - 1.1.3 Benefit consumers through lower prices, better quality and greater choice.
- 1.2 **Adopted Legislation:** The following local, state and federal regulations affirmatively authorize these innovative products to be approved by AHJs, delegates of building departments and/or delegates of an agency of the federal government:
 - 1.2.1 Interstate commerce is governed by the Federal Department of Justice to encourage the use of innovative products, materials, designs, services, assemblies and/or methods of construction. The goal is to “protect economic freedom and opportunity by promoting free and fair competition in the marketplace.”
 - 1.2.2 Title 18 US Code Section 242 affirms and regulates the right of individuals and businesses to freely and fairly have new products, materials, designs, services, assemblies and/or methods of construction approved for use in commerce. Disapproval of alternatives shall be based upon non-conformance with respect to specific provisions of adopted legislation and shall be provided in writing stating the reasons why the alternative was not approved, with reference to the specific legislation violated.
 - 1.2.3 The federal government and each state have a public records act. In addition, each state also has legislation that mimics the federal Defend Trade Secrets Act 2016 (DTSA),^{xxxviii} where providing test reports, engineering analysis and/or other related IP/TS is subject to prison of not more than ten years^{xxxix} and/or a \$5,000,000 fine or 3 times the value of^{xl} the Intellectual Property (IP) and Trade Secrets (TS).
 - 1.2.3.1 Compliance with public records and trade secret legislation requires approval through the use of Listings, certified reports, Technical Evaluation Reports, duly authenticated reports and/or research reports prepared by approved agencies and/or approved sources.
 - 1.2.4 For new materials^{xli} that are not specifically provided for in any regulation, the design strengths and permissible stresses shall be established by tests, where suitable load tests simulate the actual loads and conditions of application that occur.
 - 1.2.5 The design strengths and permissible stresses of any structural material shall conform to the specifications and methods of design using accepted engineering practice.^{xlii}
 - 1.2.6 The commerce of approved sources (i.e., registered PEs) is regulated by professional engineering legislation. Professional engineering commerce shall always be approved by AHJs, except where there is evidence provided in writing, that specific legislation has been violated by an individual registered PE.
 - 1.2.7 The AHJ shall accept duly authenticated reports from approved agencies in respect to the quality and manner of use of new materials or assemblies as provided for in IBC Section 104.11.^{xliii}



- 1.3 **Approved^{xliv} by Los Angeles:** The Los Angeles Municipal Code (LAMC) states in pertinent part that the provisions of LAMC are not intended to prevent the use of any material, device, or method of construction not specifically prescribed by LAMC. The Department shall use Part III, Recognized Standards in addition to Part II, Uniform Building Code Standards of Division 35, Article 1, Chapter IX of the LAMC in evaluation of products for approval where such standard exists for the product or the material and may use other approved standards that apply. Whenever tests or certificates of any material or fabricated assembly are required by Chapter IX of the LAMC, such tests or certification shall be made by a testing agency approved by the Superintendent of Building to conduct such tests or provide such certifications. The testing agency shall publish the scope and limitation(s) of the listed material or fabricated assembly.^{xlv} The Superintendent of Building Approved Testing Agency Roster is provided by the Los Angeles Department of Building and Safety (LADBS). The Center for Building Innovation (CBI) Certificate of Approval License is TA24945. Tests and certifications found in a DrJ Listing are LAMC approved. In addition, the Superintendent of Building shall accept duly authenticated reports from approved agencies in respect to the quality and manner of use of new materials or assemblies as provided for in the California Building Code (CBC) Section 1707.1.^{xlvi}
- 1.4 **Approved by Chicago:** The Municipal Code of Chicago (MCC) states in pertinent part that an Approved Agency is a Nationally Recognized Testing Laboratory (NRTL) acting within its recognized scope and/or a certification body accredited by the American National Standards Institute (ANSI) acting within its accredited scope. Construction materials and test procedures shall conform to the applicable standards listed in the MCC. Sufficient technical data shall be submitted to the building official to substantiate the proposed use of any product, material, service, design, assembly and/or method of construction not specifically provided for in the MCC. This technical data shall consist of research reports from approved sources (i.e., MCC defined Approved Agencies).
- 1.5 **Approved by New York City:** The 2022 NYC Building Code (NYCBC) states in part that an approved agency shall be deemed^{xlvii} an approved testing agency via ISO/IEC 17025 accreditation, an approved inspection agency via ISO/IEC 17020 accreditation and an approved product evaluation agency via ISO/IEC 17065 accreditation. Accrediting agencies, other than federal agencies, must be members of an internationally recognized cooperation of laboratory and inspection accreditation bodies subject to a mutual recognition agreement^{xlviii} (i.e., ANAB, International Accreditation Forum (IAF), etc.).
- 1.6 **Approved by Florida:** Statewide approval of products, methods, or systems of construction shall be approved, without further evaluation by:
- 1.6.1 A certification mark or listing of an approved certification agency,
 - 1.6.2 A test report from an approved testing laboratory,
 - 1.6.3 A product evaluation report based upon testing or comparative or rational analysis, or a combination thereof, from an approved product evaluation entity, or
 - 1.6.4 A product evaluation report based upon testing, comparative or rational analysis, or a combination thereof, developed, signed and sealed by a professional engineer or architect, licensed in Florida.
- 1.7 For local product approval, products or systems of construction shall demonstrate compliance with the structural wind load requirements of the Florida Building Code (FBC) through one of the following methods;
- 1.7.1 A certification mark, listing or label from a commission-approved certification agency indicating that the product complies with the code,
 - 1.7.2 A test report from a commission-approved testing laboratory indicating that the product tested complies with the code,
 - 1.7.3 A product-evaluation report based upon testing, comparative or rational analysis, or a combination thereof, from a commission-approved product evaluation entity which indicates that the product evaluated complies with the code,
 - 1.7.4 A product-evaluation report or certification based upon testing or comparative or rational analysis, or a combination thereof, developed and signed and sealed by a Florida professional engineer or Florida registered architect, which indicates that the product complies with the code, or
 - 1.7.5 A statewide product approval issued by the Florida Building Commission.



- 1.8 The [Florida Department of Business and Professional Regulation \(DBPR\)](#) website provides a listing of companies certified as a [Product Evaluation Agency](#) (i.e., EVLMiami 13692), a [Product Certification Agency](#) (i.e., CER10642) and as a [Florida Registered Engineer](#) (i.e., ANE13741).
- 1.9 **Approved by Miami-Dade County (i.e., Notice of Acceptance [NOA]):** A Florida statewide approval is an NOA. An NOA is a Florida local product approval. By Florida law, Miami-Dade County shall accept the statewide and local Florida Product Approval as provided for in Florida legislation [553.842](#) and [553.8425](#).
- 1.10 **Approved by New Jersey:** Pursuant to the 2018 Building Code of New Jersey in [IBC Section 1707.1 General](#),^{xlix} it states: “*In the absence of approved rules or other approved standards, the building official shall accept duly authenticated reports from [approved agencies](#) in respect to the quality and manner of use of new materials or assemblies as provided for in the administrative provisions of the Uniform Construction Code (N.J.A.C. 5:23)*”.^l Furthermore N.J.A.C 5:23-3.7 states: “*Municipal approvals of alternative materials, equipment, or methods of construction.*”
 - 1.10.1 **Approvals:** Alternative materials, equipment, or methods of construction shall be approved by the appropriate subcode official provided the proposed design is satisfactory and that the materials, equipment, or methods of construction are suitable for the intended use and are at least the equivalent in quality, strength, effectiveness, fire resistance, durability and safety of those conforming with the requirements of the regulations.
 - 1.10.1.1 A field evaluation label and report or letter issued by a nationally recognized testing laboratory verifying that the specific material, equipment, or method of construction meets the identified standards or has been tested and found to be suitable for the intended use, shall be accepted by the appropriate subcode official as meeting the requirements of the above.
 - 1.10.1.2 Reports of engineering findings issued by nationally recognized evaluation service programs such as but not limited to, the Building Officials and Code Administrators (BOCA), the International Conference of Building Officials (ICBO), the Southern Building Code Congress International (SBCCI), the International Code Council (ICC) and the National Evaluation Service, Inc., shall be accepted by the appropriate subcode official as meeting the requirements of the above.
 - 1.10.2 The [New Jersey Department of Community Affairs](#) has confirmed that technical evaluation reports, from any accredited entity listed by [ANAB](#), meets the requirements of item the previous paragraph, given that the listed entities are no longer in existence and/or do not provide “*reports of engineering findings*”.
- 1.11 **Approved by the Code of Federal Regulations Manufactured Home Construction and Safety Standards:** Pursuant to Title 24, Subtitle B, Chapter XX, [Part 3282.14](#)^{li} and [Part 3280](#),^{lii} the Department encourages innovation and the use of new technology in manufactured homes. The design and construction of a manufactured home shall conform to the provisions of Part 3282 and Part 3280 where key approval provisions in mandatory language follow:
 - 1.11.1 “*All construction methods shall be in conformance with accepted engineering practices*”
 - 1.11.2 “*The strength and rigidity of the component parts and/or the integrated structure shall be determined by engineering analysis or by suitable load tests to simulate the actual loads and conditions of application that occur.*”
 - 1.11.3 “*The design stresses of all materials shall conform to accepted engineering practice.*”



- 1.12 **Approval by US, Local and State Jurisdictions in General:** In all other local and state jurisdictions, the adopted building code legislation states in pertinent part that:
- 1.12.1 For new materials that are not specifically provided for in this code, the design strengths and permissible stresses shall be established by tests.^{liii}
 - 1.12.2 For innovative alternatives and/or methods of construction, the building official shall accept duly authenticated reports from approved agencies with respect to the quality and manner of use of new materials or assemblies.^{liv}
 - 1.12.2.1 An approved agency is “approved” when it is ANAB ISO/IEC 17065 accredited. DrJ Engineering, LLC (DrJ) is in the ANAB directory.
 - 1.12.2.2 An approved source is “approved” when an RDP is properly licensed to transact engineering commerce. The regulatory authority governing approved sources is the state legislature via its professional engineering regulations.^{lv}
 - 1.12.3 The design strengths and permissible stresses of any structural material...shall conform to the specifications and methods of design of accepted engineering practice performed by an approved source.^{lvi}
- 1.13 **Approval by International Jurisdictions:** The USMCA and GATT agreements provide for approval of innovative materials, designs, services and/or methods of construction through the Agreement on Technical Barriers to Trade and the IAF Multilateral Recognition Arrangement (MLA), where these agreements:
- 1.13.1 State that conformity assessment procedures (i.e., ISO/IEC 17020, 17025, 17065, etc.) are prepared, adopted and applied so as to grant access for suppliers of like products originating in the territories of other Members under conditions no less favourable than those accorded to suppliers of like products of national origin or originating in any other country, in a comparable situation.
 - 1.13.2 **Approved:** The purpose of the MLA is to ensure mutual recognition of accredited certification and validation/verification statements between signatories to the MLA and subsequently, acceptance of accredited certification and validation/verification statements in many markets based on one accreditation for the timely approval of innovative materials, designs, services and/or methods of construction.
 - 1.13.3 ANAB is an IAF-MLA signatory where recognition of certificates, validation and verification statements issued by conformity assessment bodies accredited by all other signatories of the IAF MLA, with the appropriate scope, shall be approved.^{lvii}
 - 1.13.4 Therefore, all ANAB ISO/IEC 17065 Duly Authenticated Reports are approval equivalent.^{lviii}
- 1.14 Approval equity is a fundamental commercial and legal principle.^{lix}



Notes

- i For more information, visit drjcertification.org or call us at 608-310-6748.
- ii <https://up.codes/viewer/wyoming/ibc-2021/chapter/17/special-inspections-and-tests#1702>
- iii Alternative Materials, Design and Methods of Construction and Equipment: The provisions of any regulation code are not intended to prevent the installation of any material or to prohibit any design or method of construction not specifically prescribed by a regulation. Please review https://www.justice.gov/atr/mission_and <https://up.codes/viewer/colorado/ibc-2021/chapter/1/scope-and-administration#104.11>
- iv <https://up.codes/viewer/wyoming/ibc-2021/chapter/17/special-inspections-and-tests#1706>:-:text=the%20design%20strengths%20and%20permissible%20stresses%20shall%20be%20established%20by%20tests%20as
- v The design strengths and permissible stresses of any structural material shall conform to the specifications and methods of design of accepted engineering practice. <https://up.codes/viewer/wyoming/ibc-2021/chapter/17/special-inspections-and-tests#1706>:-:text=shall%20conform%20to%20the%20specifications%20and%20methods%20of%20design%20of%20accepted%20engineering%20practice
- vi <https://up.codes/viewer/wyoming/ibc-2021/chapter/17/special-inspections-and-tests#1707.1>:-:text=the%20building%20official%20shall%20accept%20duly%20authenticated%20reports%20from%20approved%20agencies
- vii <https://up.codes/viewer/wyoming/ibc-2021/chapter/17/special-inspections-and-tests#1703.4.2>
- viii https://up.codes/viewer/wyoming/ibc-2021/chapter/2/definitions#approved_agency
- ix https://up.codes/viewer/wyoming/ibc-2021/chapter/2/definitions#approved_source
- x <https://www.law.cornell.edu/uscode/text/18/1832> (b) Any organization that commits any offense described in subsection (a) shall be fined not more than the greater of \$5,000,000 or 3 times the value of the stolen trade secret to the organization, including expenses for research and design and other costs of reproducing the trade secret that the organization has thereby avoided. The federal government and each state have a public records act. To follow DTSA and comply state public records and trade secret legislation requires approval through ANAB ISO/IEC 17065 accredited certification bodies or approved sources. For more information, please review this website: Intellectual Property and Trade Secrets.
- xi <https://www.nspe.org/resources/issues-and-advocacy/professional-policies-and-position-statements/regulation-professional> AND <https://apassociation.org/list-of-engineering-boards-in-each-state-archive/>
- xii <https://www.cbittest.com/accreditation/>
- xiii <https://up.codes/viewer/colorado/ibc-2021/chapter/1/scope-and-administration#104>:-:text=to%20enforce%20the%20provisions%20of%20this%20code
- xiv <https://up.codes/viewer/colorado/ibc-2021/chapter/1/scope-and-administration#104.11>:-:text=Where%20the%20alternative%20material%2C%20design%20or%20method%20of%20construction%20is%20not%20approved%2C%20the%20building%20official%20shall%20respond%20in%20writing%2C%20stating%20the%20reasons%20why%20the%20alternative%20was%20not%20approved AND <https://up.codes/viewer/colorado/ibc-2021/chapter/1/scope-and-administration#105.3.1>:-:text=If%20the%20application%20or%20the%20construction%20documents%20do%20not%20conform%20to%20the%20requirements%20of%20pertinent%20laws%2C%20the%20building%20official%20shall%20reject%20such%20application%20in%20writing%2C%20stating%20the%20reasons%20therefore
- xv <https://up.codes/viewer/colorado/ibc-2021/chapter/17/special-inspections-and-tests#1707.1>:-:text=the%20building%20official%20shall%20accept%20duly%20authenticated%20reports%20from%20approved%20agencies%20in%20respect%20to%20the%20quality%20and%20manner%20of%20use%20of%20new%20materials%20or%20assemblies%20as%20provided%20for%20in%20Section%20104.11
- xvi <https://iaf.nu/en/about-iaf-mia/#>:-:text=it%20is%20required%20to%20recognise%20certificates%20and%20validation%20and%20verification%20statements%20issued%20by%20conformity%20assessment%20bodies%20accredited%20by%20all%20other%20signatories%20of%20the%20IAF%20MLA%2C%20with%20the%20appropriate%20scope
- xvii True for all ANAB accredited product evaluation agencies and all International Trade Agreements.
- xviii <https://www.justice.gov/crt/deprivation-rights-under-color-law> AND <https://www.justice.gov/atr/mission>
- xix Unless otherwise noted, all references in this Listing are from the 2021 version of the codes and the standards referenced therein. This material, product, design, service and/or method of construction also complies with the 2000-2021 versions of the referenced codes and the standards referenced therein.
- xx <https://www.ecfr.gov/current/title-24/subtitle-B/chapter-XX/part-3280#p-3280.2>(Listed%20or%20certified); <https://up.codes/viewer/colorado/ibc-2021/chapter/2/definitions#listed> AND <https://up.codes/viewer/colorado/ibc-2021/chapter/2/definitions#labeled>
- xxi 2015 IBC Section 1404.2
- xxii 2018 IECC Section C402.5.1.2.1
- xxiii <https://up.codes/viewer/colorado/ibc-2021/chapter/17/special-inspections-and-tests#1703.4>
- xxiv <https://www.ecfr.gov/current/title-24/subtitle-B/chapter-XX/part-3280#>:-:text=All%20construction%20methods%20shall%20be%20in%20conformance%20with%20accepted%20engineering%20practices%20to%20insure%20durable%2C%20livable%2C%20and%20safe%20housing%20and%20shall%20demonstrate%20acceptable%20workmanship%20reflecting%20journeyman%20quality%20of%20work%20of%20the%20various%20trades
- xxv <https://www.ecfr.gov/current/title-24/subtitle-B/chapter-XX/part-3280#>:-:text=The%20strength%20and%20rigidity%20of%20the%20component%20parts%20and/or%20the%20integrated%20structure%20shall%20be%20determined%20by%20engineering%20analysis%20or%20by%20suitable%20load%20tests%20to%20simulate%20the%20actual%20loads%20and%20conditions%20of%20application%20that%20occur
- xxvi 2015 IBC Section 1404.2
- xxvii 2015 IBC Section 1405.3
- xxviii 2018 IECC Section C402.5.1.2.1
- xxix Qualification is performed by a legislatively defined Accreditation Body. ANSI National Accreditation Board (ANAB) is the largest independent accreditation body in North America and provides services in more than 75 countries. DrJ is an ANAB accredited product certification body.



- xxx See Code of Federal Regulations (CFR) [Title 24 Subtitle B Chapter XX Part 3280](#) for definition.
- xxxi [2015 IBC Section 1404.2](#)
- xxxii [2018 IECC Section C402.5.1.2.1](#)
- xxxiii [2018 IFC Section 104.9](#)
- xxxiv Approved is an adjective that modifies the noun after it. For example, Approved Agency means that the Agency is accepted officially as being suitable in a particular situation. This example conforms to IBC/IRC/IFC [Section 201.4](#) where the building code authorizes sentences to have an ordinarily accepted meaning such as the context implies.
- xxxv <https://up.codes/viewer/wyoming/ibc-2021/chapter/17/special-inspections-and-tests#1707.1>
- xxxvi Multilateral approval is true for all ANAB accredited product evaluation agencies and all International Trade Agreements.
- xxxvii [2018 IBC Section 1705.11](#)
- xxxviii <http://www.drjengineering.org/AppendixC> AND <https://www.dricertification.org/cornell-2016-protection-trade-secrets>
- xxxix <https://www.law.cornell.edu/uscode/text/18/1832#:~:text=imprisoned%20not%20more%20than%2010%20years>
- xl <https://www.law.cornell.edu/uscode/text/18/1832#:~:text=Any%20organization%20that,has%20thereby%20avoided>
- xli <https://up.codes/viewer/wyoming/ibc-2021/chapter/17/special-inspections-and-tests#1706.2>
- xlii [IBC 2021, Section 1706.1 Conformance to Standards](#)
- xliii [IBC 2021, Section 1707 Alternative Test Procedure, 1707.1 General](#)
- xliv See Section 11 for the distilled building code definition of **Approved**
- xlv [Los Angeles Municipal Code, SEC. 98.0503. TESTING AGENCIES](#)
- xlvi <https://up.codes/viewer/california/ca-building-code-2022/chapter/17/special-inspections-and-tests#1707.1>
- xlvii [New York City, The Rules of the City of New York, § 101-07 Approved Agencies](#)
- xlviii [New York City, The Rules of the City of New York, § 101-07 Approved Agencies](#)
- xlvi <https://up.codes/viewer/new-jersey/ibc-2018/chapter/17/special-inspections-and-tests#1707.1>
- i <https://www.nj.gov/dca/divisions/codes/codreg/ucc.html>
- ii <https://www.ecfr.gov/current/title-24/subtitle-B/chapter-XX/part-3282/subpart-A/section-3282.14>
- iii <https://www.ecfr.gov/current/title-24/subtitle-B/chapter-XX/part-3280>
- iiii [IBC 2021, Section 1706 Design Strengths of Materials, 1706.2 New Materials.](#) Adopted law pursuant to IBC model code language 1706.2.
- lv [IBC 2021, Section 1707 Alternative Test Procedure, 1707.1 General.](#) Adopted law pursuant to IBC model code language 1707.1.
- lv <https://www.nspe.org/resources/issues-and-advocacy/professional-policies-and-position-statements/regulation-professional-boards-in-each-state-archive/> AND <https://apassociation.org/list-of-engineering-boards-in-each-state-archive/>
- lvi [IBC 2021, Section 1706 Design Strengths of Materials, Section 1706.1 Conformance to Standards](#) Adopted law pursuant to IBC model code language 1706.1.
- lvii <https://iaf.nu/en/about-iaf-mia/#:~:text=it%20is%20required%20to%20recognise%20certificates%20and%20validation%20and%20verification%20statements%20issued%20by%20conformity%20assessment%20bodies%20accredited%20by%20all%20other%20signatories%20of%20the%20IAF%20MLA%2C%20with%20the%20appropriate%20scope>
- lviii True for all ANAB accredited product evaluation agencies and all International Trade Agreements.
- lix <https://www.justice.gov/crt/deprivation-rights-under-color-law> AND <https://www.justice.gov/atr/mission>